

PW 500.6 (W) - 1000.6 (W) | PW 750.6 PN6 (W)

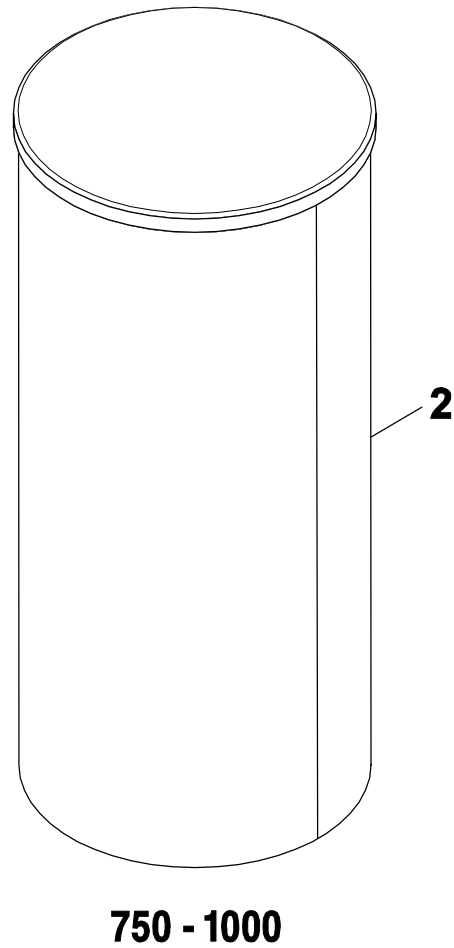
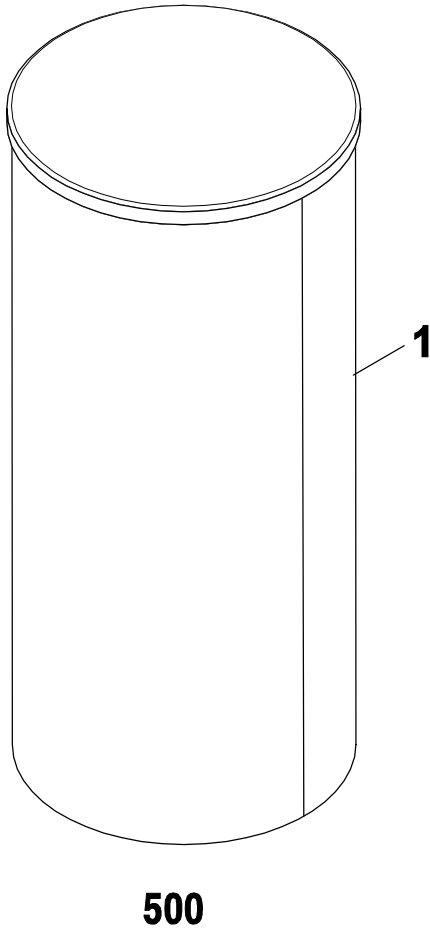

8738893720.aa.R

Buderus

[de] Wichtige Hinweise zur Installation/Montage

Die Installation/Montage muss durch eine für die Arbeiten zugelassene Fachkraft unter Beachtung der geltenden Vorschriften erfolgen.

[en] Important notes on installation/assembly

The installation/assembly must be carried out by a professional who is authorised to do the work, and with due regard to the relevant regulations.

[fr] Instructions importantes pour l'installation/le montage

L'installation/le montage doit être effectué(e) par un spécialiste qualifié pour les opérations concernées et dans le respect des prescriptions applicables.

[bg] Важни указания във връзка с инсталацията/монтажа

Инсталацията/монтажът трябва да се извършва от лицензиран за работите специалист в съответствие с приложимите разпоредби.

[cs] Důležité pokyny k instalaci/montáži

Instalaci/montáž musí při dodržení platných předpisů provést odborný pracovník s příslušným oprávněním pro tyto práce.

[da] Vigtige anvisninger til installationen/monteringen

Installationen/monteringen skal foretages af en godkendt installatør under overholdelse af de gældende forskrifter.

[el] Σημαντικές υποδείξεις για την εγκατάσταση/συναρμολόγηση

Η εγκατάσταση/συναρμολόγηση πρέπει να πραγματοποιείται από εξουσιοδοτημένο για τις εργασίες αυτές τεχνικό προσωπικό, το οποίο θα πρέπει να φροντίζει ώστε να τηρούνται οι ισχύουσες διατάξεις.

[es] Indicaciones importantes para instalación/montaje

La instalación/el montaje lo debe realizar personal especializado autorizado para los trabajos, respetando las prescripciones vigentes.

[et] Olulised juhised paigaldamiseks/montaažiks

Paigaldamist/montaaži tohib läbi viia selleks volitusi omav spetsialist, arvestades kehtivaid nõudeid.

[fi] Belangrijke aanwijzingen betreffende de installatie/montage

De installatie/montage moet worden uitgevoerd door een voor de werkzaamheden geautoriseerde installateur. Hij moet rekening houden met de geldende voorschriften.

[fi] Tärkeitä asennus- ja kokoonpano-ohjeita

Näihin töihin hyväksytyin ammattiasentajan pitää suorittaa asennus- ja kokoonpanotyöt voimassa olevien määräysten mukaisesti.

[hu] Fontos tudnivalók az installáláshoz/szereléshez

Az installálást/szerelést egy, a munkákra felhatalmazott szakembernek kell végeznie, az érvényes előírások figyelembevételével.

[it] Avvertenze importanti per l'installazione/il montaggio

L'installazione/il montaggio deve aver luogo ad opera di una ditta specializzata ed autorizzata in osservanza delle disposizioni vigenti.

[he] מניפולציות/מонтаזים חשובות לביצוע/התקנת המכשיר

התקנת המכשיר/התקנת המכשיר חייבת להיעשות על ידי מומחה מוסמך, המעביר את המכשיר באופן נכון. יש להקפיד על כללי הבטיחות הנלווים.

[it] Svarbios instaliavimo ir (arba) montavimo nuorodos

Instaliuoti ir montuoti, laikantis galiojančių taisyklių, leidžiama kvalifikuotiems specialistams, kurie buvo įgalioti šioms darbams atlikti.

[lv] Svarīgi norādījumi par iekārtas uzstādīšanu / montāžu

Iekārtas uzstādīšanu/montāžu ir jāveic specializētam sertificētam speciālistam, ievērojot spēkā esošos noteikumus.

[nl] Belangrijke aanwijzingen betreffende de installatie/montage

De installatie/montage moet worden uitgevoerd door een voor de werkzaamheden geautoriseerde installateur rekening houdend met de geldende voorschriften.

[no] Viktig informasjon om installasjon/montering

Installasjonen/monteringen skal gjennomføres av autoriserte installatører, og gjeldende forskrifter skal følges.

[pl] Ważne wskazówki dotyczące instalacji/montażu

Instalacja /montaż muszą być wykonane przez uprawnionego do tego rodzaju prac specjalistę przy zachowaniu obowiązujących przepisów.

[pt] Indicações importantes relativas à instalação/montagem

A instalação/montagem deve ser efetuada por um técnico especializado com qualificações para estes trabalhos, tendo em atenção os regulamentos em vigor.

[ro] Indicații importante privind instalarea/montajul

Instalarea/montajul trebuie realizate de către un specialist autorizat pentru lucrările respective, respectându-se prescripțiile valabile.

[ru] Важные указания по подключению/монтажу

Подключение/монтаж должны выполнять специалисты, имеющие допуск к выполнению таких работ, при соблюдении действующих норм и правил.

[sk] Dôležité pokyny týkajúce sa inštalácie/montáže

Inštaláciu/montáž musí realizovať odborník s oprávnením na výkon týchto prác, pričom musí dodržiavať platné predpisy.

[sl] Pomembni napotki za nameštitev/montažo

Nameštitev/montažo mora izvesti strokovnjak, pristojen za tovrstna dela, ob upošte vanju veljavnih predpisov.

[sr] Važna uputstva za ugradnju i montažu

Ugradnju i montažu moraju da obave samo stručna lica ovlašćena za izvođenje takvih radova koja će poštovati važeće propise.

[sv] Viktiga anvisningar för installation/montering

Installationen/monteringen måste utföras av en behörig och fackkunnig person enligt gällande föreskrifter.

[tr] Kurulum/Montaj ile ilgili önemli uyarılar

Kurulum/Montaj çalışmaları sadece yetkili bayiler tarafından aşağıda belirtilen talimatlar dikkate alınarak yapılmalıdır.

[uk] Важливі вказівки щодо установки/монтажу

Установку/монтаж мають здійснювати фахівці, що мають дозвіл на проведення цих робіт, із дотримання чинних приписів.

[zh] 安装方面的重要提示

必须由受到许可承担该项工作的专业人员遵照相关法规进行安装。

[ar] ملاحظات هامة للتثبيت/التجميع

يجب أن يتم التثبيت/التجميع من قبل متخصص مصرح له بالعمل، مع مراعاة اللوائح السارية.





[fa] نکات مهم درباره نصب/مونتاژ

نصب/مونتاژ باید توسط فردی حرفه ای که مجاز به انجام این کار است، و همچنین با توجه کامل به مقررات مربوطه انجام شود.

Ersatzteilliste
Spare parts list

Liste des pièces de rechange
Lista parti di ricambio

Onderdelenlijst
Lista de repuestos

- 4x  80x30x2
- 4x  80x34x2
- 8 — 2x  90x43x2
- 2x  100x48x2
- 6x  110x55x2

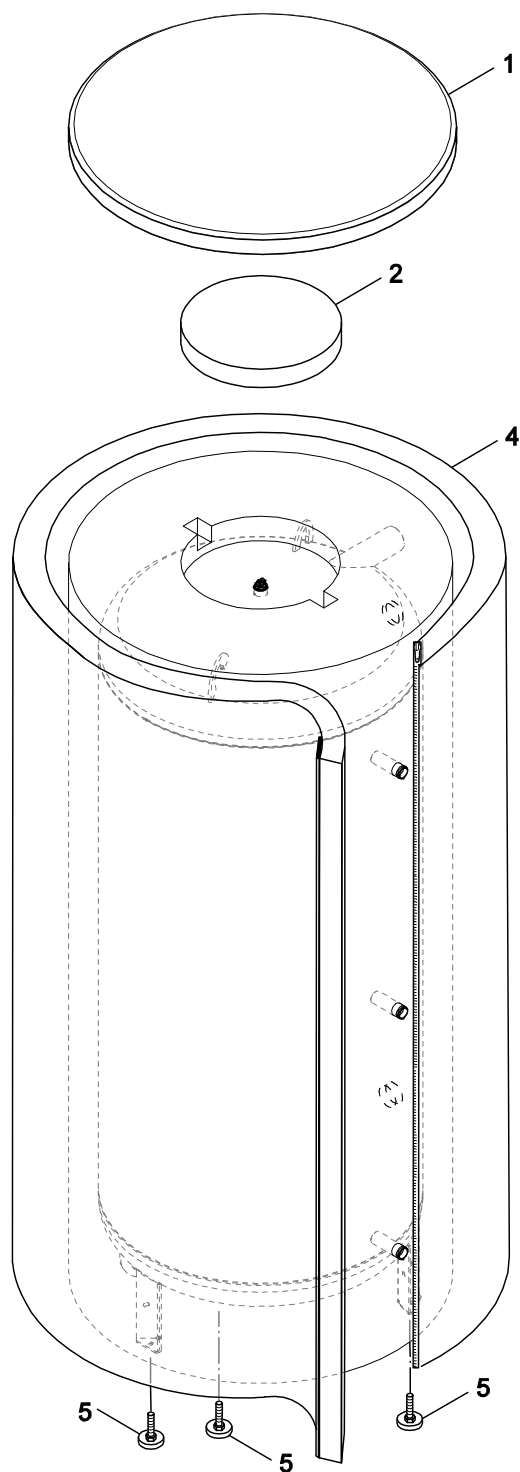
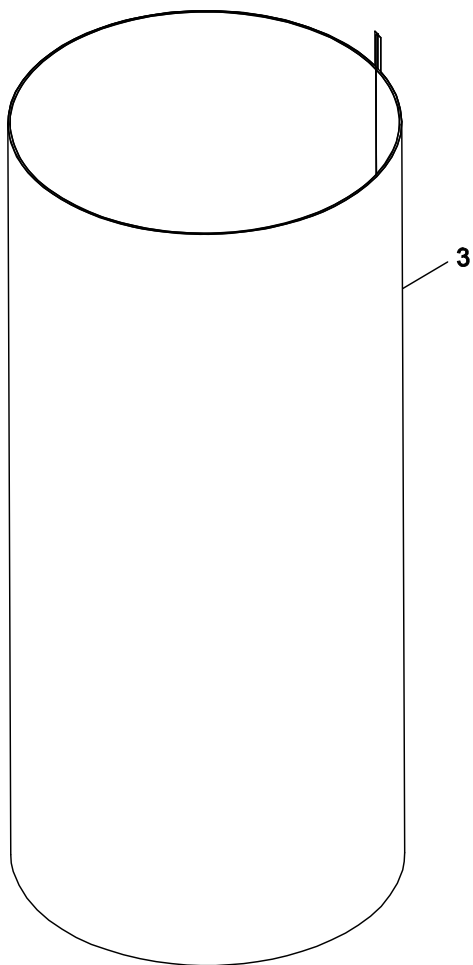

8738893721.aa.R

1

Pufferspeicher PW 500.6
Buffer cylinder PW 500.6
Ballon tampon PW 500.6
Accumulatore puffer PW 500.6
Bufferboiler PW 500.6
Acumulador auxiliar PW 500.6

PW 500.6 (W) - 1000.6 (W) | PW 750.6 PN6 (W)



Pos	Bezeichnung Description Dénomination Descrizioni Benaming Descripción	Bestell-Nr. Ordering no. Numéro de commande N° d'ordine Bestelnummer Número el ordenar	PW500.6 W-B	PW500.6 W-C	PW500.6-B	PW500.6-C																	Bemerkungen Remarks Remarques Osservazioni Opmerkingen Observaciones	
1	Verkleidungsdeckel D850 Schwarz	8 735 100 268	■		■																			
1	Abdeckung D783 Deckel schwarz	8 735 100 269		■		■																		
2	Weichschaum Rosette D320x0x50	8 735 100 272	■	■	■	■																		
3	Folienmantel P500 weiß	8 735 100 578		■																				
3	Folienmantel P500 blau	8 735 100 579				■																		
4	Isolation P500 ErP B weiss/schwarz	8 735 100 580	■																					
4	Isolation P500 ErP B blau/schwarz	8 735 100 581			■																			
5	Zubehör Stellfuß Speicher 500-1000L 3 ST	8 718 590 658	■	■	■	■																		
8	Set Rosetten selbstklebend S	8 735 100 321	■	■	■	■																		
	Logo Buderus	8 718 224 253 0	■	■	■	■																		





PW 500.6 (W) - 1000.6 (W) PW 750.6 PN6 (W)	Pufferspeicher PW 500.6 Buffer cylinder PW 500.6 Ballon tampon PW 500.6 Accumulatore puffer PW 500.6 Bufferboiler PW 500.6 Acumulador auxiliar PW 500.6	1
-----------------------------------------------------	------------------------------------------------------------------------------------------------------------------------------------------------------------------------	---

Ersatzteilliste
Spare parts list

Liste des pièces de rechange
Lista parti di ricambio

Onderdelenlijst
Lista de repuestos

- 6x  D90x38x20
- 12x  D90x25x20
- 1x  D140x58x20

- 4x  80x30x2
- 4x  80x34x2
- 15x  90x43x2
- 2x  100x48x2
- 6x  110x55x2

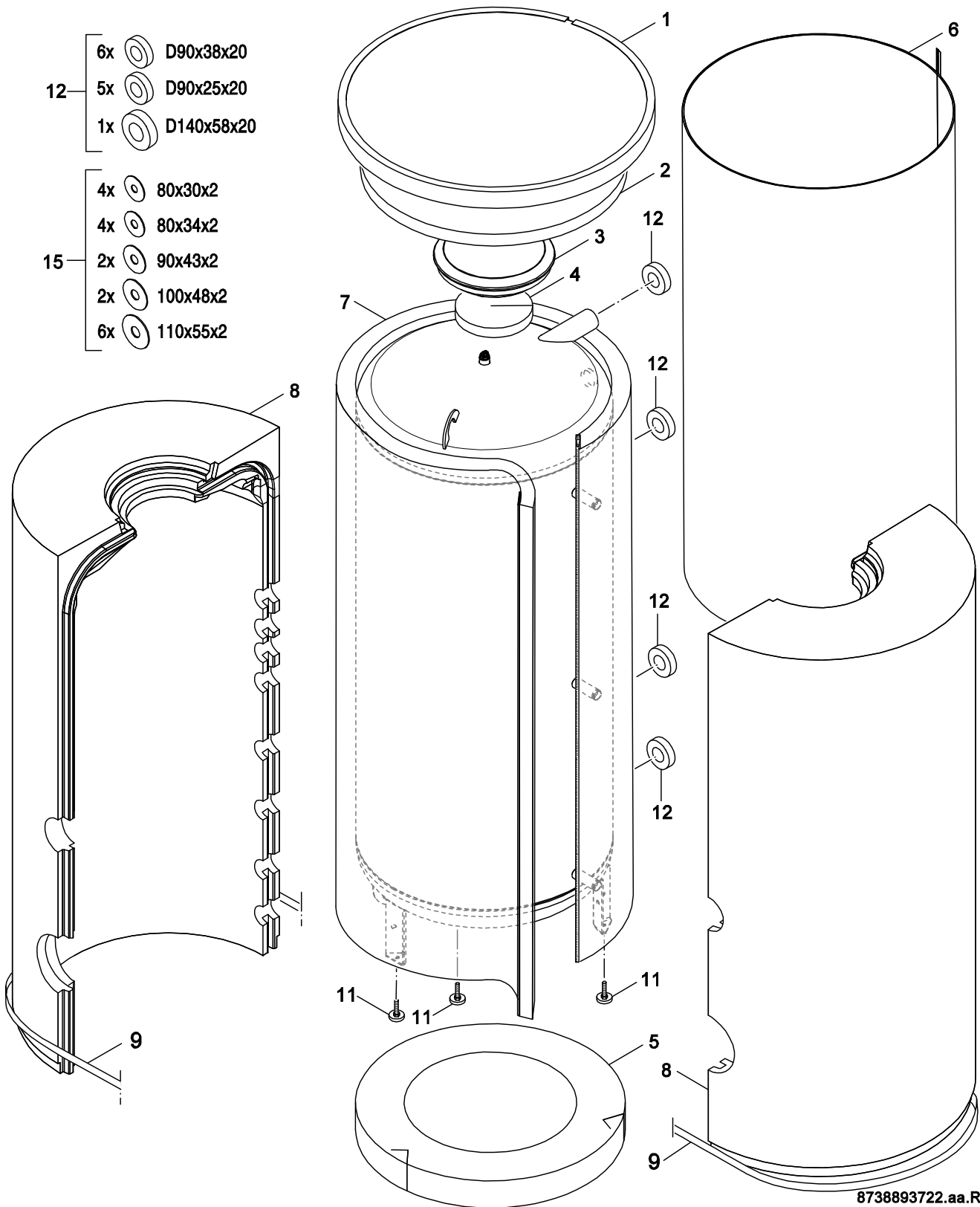

8738893722.aa.R

2

Pufferspeicher PW 750.6 - 1000.6
Buffer cylinder PW 750.6 - 1000.6
Ballon tampon PW 750.6 - 1000.6
Accumulatore puffer PW 750.6 - 1000.6
Bufferboiler PW 750.6 - 1000.6
Acumulador auxiliar PW 750.6 - 1000.6

PW 500.6 (W) - 1000.6 (W) | PW 750.6 PN6 (W)

Gerätetypen Types of appliances	Types de chaudières Tipo apparecchi	Toesteltypes Tipos de aplicaciones		
Gerät Appliance Chaudière Apparecchio Toestel Aparato	Bestell-Nr. Ordering no. Numéro de commande N° d'ordine Bestelnummer Número el ordenar	Land Country Pays Paese Land Paese	S-Nr. S-Nr. S-Nr. S-Nr. S-Nr.	Bemerkungen Remarks Remarques Osservazioni Opmerkingen Observaciones
PW500.6 W-C	7 735 500 817	Belgien, Deutschland, Luxemburg, Polen		
PW750.6 W-C	7 735 500 829	Belgien, Deutschland, Luxemburg, Polen,		
PW1000.6 W-C	7 735 500 837	Belgien, Deutschland, Luxemburg, Polen,		
PW500.6-C	7 735 501 282	Belgien, Deutschland, Polen		
PW750.6-C	7 735 500 828	Belgien, Deutschland, Polen, Schweiz,		
PW1000.6-C	7 735 500 836	Belgien, Deutschland, Polen, Schweiz,		
PW750.6 PN6 W-C	7 735 500 845	Belgien, Polen, Slowakei, Österreich		
PW750.6 PN6-C	7 735 500 844	Belgien, Polen, Slowakei, Österreich		
PW500.6 W-B	7 739 610 700	Deutschland		
PW500.6-B	7 739 610 699	Deutschland		
Puffer PW750.6 PN6-E	8 735 100 411	Deutschland, Polen		
PW750.6 PN6 W-E	7 735 500 841	Deutschland, Polen		
PW750.6 PN6-E	7 735 500 840	Deutschland, Polen		
PW500.6 W-B	7 735 500 821	Deutschland, Polen, Schweiz, Slowakei,		
PW500.6-B	7 735 500 820	Deutschland, Polen, Schweiz, Slowakei,		
Puffer PW750.6-E	8 735 100 407	Deutschland, Polen, Slowakei		
Puffer PW1000.6-E	8 735 100 409	Deutschland, Polen, Slowakei		
PW750.6 W-E	7 735 500 825	Deutschland, Polen, Slowakei		
PW750.6-E	7 735 500 824	Deutschland, Polen, Slowakei		
PW1000.6 W-E	7 735 500 833	Deutschland, Polen, Slowakei		
PW1000.6-E	7 735 500 832	Deutschland, Polen, Slowakei		

